

## PROPOSAL OF NEW MAINTENANCE SCHEME OF AIR BRAKE SYSTEM ON SEMI-TRAILER COMBINATION

František RUMAN, Juraj GREŇČÍK

Department of Transport and Handling Machines, University of Zilina, Univerzitná 1, 010 26 ŽILINA, Slovakia  
[frantisek.ruman@fstroj.uniza.sk](mailto:frantisek.ruman@fstroj.uniza.sk), [juraj.grencik@fstroj.uniza.sk](mailto:juraj.grencik@fstroj.uniza.sk), +4215132553.

### Summary

The paper deals with the proposal of new maintenance scheme of air brake system on a semi-trailer combination. The structure of semi-trailer and the current maintenance scheme of trailers are described with focus on the basic air brake system design. Analysis of wear and damage of air brake system components used on the semi-trailer combination based on real experience from practice and creation of the FMECA analysis of the system using software support are presented. Based on the analysis performed, a new scheme of maintenance was designed which was aimed at reduction of the risk related to failure consequences. Main objective was to reduce the impact of any failure in any component on the air brake system. Proposed intervals of preventive maintenance execution are based on the calculation of the total costs associated with the consequences of failures that may arise from them and compared with costs associated with service inspections carried out on the analysed semi-trailer fleet.

Keywords: air brake system, FMECA, RPN, semi – trailer combination, maintenance

### PROPOZYCJA NOWEGO SYSTEMU EKSPLOATACJI PNEUMATYCZNEGO UKŁADU HAMULCOWEGO NACZEPY

#### Streszczenie

W niniejszym artykule zaprezentowano nowy system eksploatacji pneumatycznego układu hamulcowego naczepy. Opisano w nim także obecną strukturę systemu technicznego naczepy z uwzględnieniem podstawowego układu hamulcowego. Przedstawiono opartą o rzeczywiste wyniki badań komputerową analizę zużycia i uszkodzeń elementów układu hamulcowego z wykorzystaniem metody FMEA. Na jej podstawie zaprojektowano nowy system eksploatacji analizowanego układu hamulcowego, charakteryzujący się zmniejszonym ryzykiem wystąpienia awarii. Głównym celem projektu było zredukowanie ryzyka wystąpienia uszkodzeń poszczególnych elementów układu hamulcowego. Zaproponowane terminy przeglądów profilaktycznych są wynikiem porównania ogółu kosztów wynikających ze skutków możliwych awarii a kosztami związanymi z kontrolą serwisową dla analizowanej grupy naczep.

Słowa kluczowe: pneumatyczny układ hamulcowy, FMECA, RPN, naczepa, eksploatacja

## 1. INTRODUCTION

To keep operation of any technical system reliable, maintenance is always necessary. As the technical complexity of technical systems developed within the history so the maintenance schemes and strategies evolved [11].

Fundamental question of any maintenance is what and should be done to fix or prevent a failure. Depending on failure consequences, basically corrective or preventive maintenance is chosen [11]. It is always combination of technical and organisational measures that are involved in maintenance activities. Firstly technical aspects of failures should be investigated and revealed but consequently organisational measures (what, when, who and how) should be arranged.

Lot of research have been done in the area of finding an optimum maintenance schemes. They are focused on determination of optimum inspection and preventive maintenance intervals [15, 2], models of

maintenance processes [9] and effective maintenance strategies [8].

Many researchers are doing deep investigation of physical (technical) processes by their simulation with the aim to discover excessive loads and phenomena leading to failure. There are vast numbers of technical systems being operated in various sectors. An important sector that can be found virtually anywhere is transport, especially road transport. Wheeled vehicles are everywhere bringing lot of benefits for economy, yet causing lot of problems (environment, safety etc.). From the safety point of view, brakes are among the most important issues of road vehicles. So naturally the brake system maintenance and its diagnosis have been in focus. This can be found e.g. in the works [6, 7] where mathematical modelling was used for simulation of brake systems and their diagnostics.

The most commonly used means of transport in road freight transport is a semi-trailer combination.

Therefore maintenance of selected parts (brakes) of semi-trailer combination was solved in our research.

Function of air brake system on semi-trailer is to ensure deceleration, stopping and parking a semi-trailer. Two systems are used in practice, which are anti-block system ABS and electronic braking system EBS. The research was focused only to electronic braking system EBS.

The structure of semi-trailer and the current maintenance scheme of trailers are described with focus on the air brake system design. Following an analysis of wear and damage of air brake system components used on the semi-trailer combination based on real experience from practice and creation of the FMECA (Failure Modes, Effects and Criticality Analysis) analysis of the system using a software support were done. Based on the analysis performed, a new scheme of maintenance scheme was proposed, which was aimed at reduction of the risk. The proposed scheme uses RPN (risk priority number) values resulting from proposed preventive maintenance and is compared with the current maintenance scheme. Main objective was to reduce the impact of any failure in any component on the air brake system reliability.



Fig. 1. Three-axle sliding tarpaulin platform semi-trailer PANAV [5]

## 2. RESEARCH OBJECT AND METHODS

The object of the research was semi-trailer. According to EEC standards, the most important parameters of semi-trailer combinations are:

- total weight,
- maximum load on each axle,
- total length and width,
- total cargo volume for goods transported.

### 2.1. Semi-trailer and it's subsystems

The main components, described for a 3-axle sliding tarpaulin platform semi-trailer, are:

1. Frame, king pin, support fixtures, axles, air brake system, side impact protection, rear bumper, superstructure, floor.
2. Accessories: spare wheel bracket for spare wheel, water tank, plastic toolbox, retractable step unit.

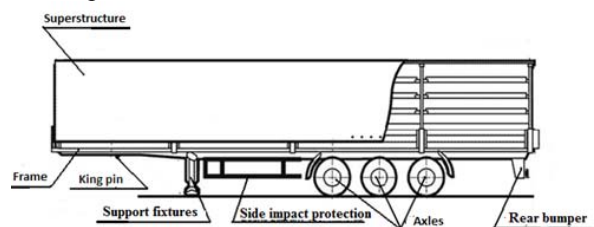

Fig. 2. Schematic description of basic semi-trailer components [5]

Air brake system has direct influence on driving safety in road traffic. The main function of the entire brake system is controlled by EBS. The air brake system consists of two branches - air and electrical (EBS).

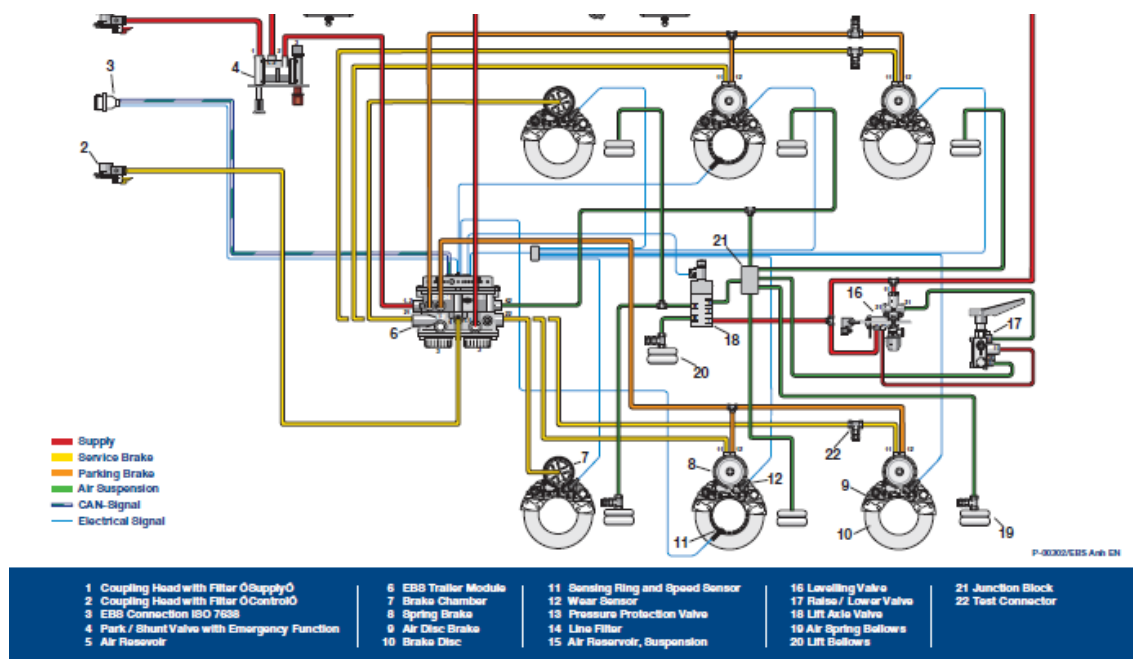

Fig. 3. Air brake system [5]

## 2.2. The FMECA analysis

Risk Management should be an integral part of an Integrated Management System. Risks can be reduced amongst others by improved organization, business processes, among them by maintenance.

FME(C)A (Failure Modes, Effects and Criticality Analysis) is an important, established preventive quality method/ procedure with a long history. It is an inductive (bottom up) method –derived from failure causes and modes, effects on the next higher level of a system are determined. In order to understand the failure mechanism within FMEA “an appropriate depth of information on the causes of failure (deductive analysis)” is necessary [14, 12].

FME(C)A can support reliability analysis and allows highlighting safety risks. Risks can be qualitatively or quantitatively determined by evaluating "hard facts". Effects and causes of failures of a product, process or service are determined. Failure should be prevented and risks reduced at an early point of time in product and process development in order to save money and to reduce legal risks.

The occurrence of failure should be prevented by suitable actions i.e. by removing causes for failures or by actions to mitigate effects of failures. The following graph (fig. 4) is showing the connection between failure prevention and failure detection.

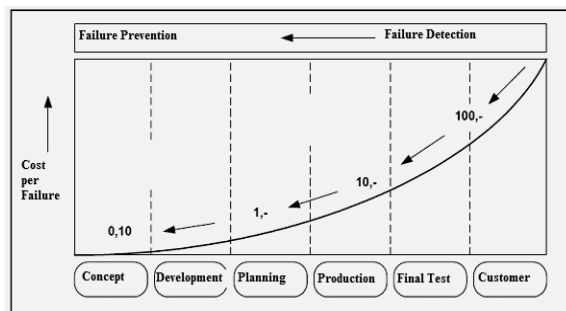

Fig. 4. "Rule of ten" for failure correction [18]

Every company should strive to reduce quality costs to a minimum. Quality costs include "failure costs" (i.e. rework, scrap and external costs); preventive costs (i.e. FMEA) and costs for testing (for equipment and personnel). It is important to use modern quality tools and to set up an excellent organization to reach the optimum on quality costs as shown in figure 5.

FMEA is a must amongst others in military, automotive, aerospace industry and in railway and nuclear industry. Further examples for sectors of application are food industry, medical industry, drug administration, hospitals and service.

Furthermore, FMEA is an integral content of other quality procedures which are applied as problem solving tools in automotive industry.

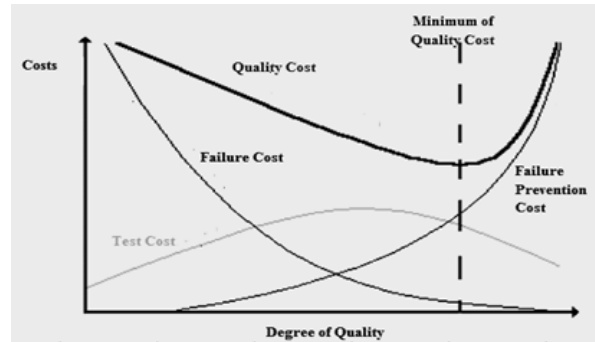

Fig. 5. "Rule of ten" for failure correction [19]

There are various procedures for FMEA which have been developed for special applications. Basically, it can be distinguished between Design and Process FMEA.

There is close connection between the quality of applying the FMEA tool and failure preventive costs. With increasing quality / effort for applying the tools preventive costs do increase. However, internal failures costs / manufacturing costs do decrease with increasing quality of applying the FMEA.

The FMECA analysis of EBS system was done with the criticality analysis of nodes, including functional and fault networks.

The first step is to create the structure of the air brake system. It is also necessary to establish the elements of the structure and their functions and failures. Then we can create function networks and failure networks. The next step in the FMECA analysis is a risk assessment. Values of probability, severity and detection are entered into FMECA forms [16, 17].

FMECA procedure:

1. For each process input (start with high value inputs), determine the ways in which the input can go wrong (failure mode).
2. For each failure mode, determine effects.
  - Select a severity level for each effect.
3. Identify potential causes of each failure mode.
  - Select an occurrence level for each cause.
4. List current controls for each cause.
  - Select a detection level for each cause.
5. Calculate the Risk Priority Number (RPN).
6. Develop recommended actions, assign responsible persons, and take actions.
7. Assign the predicted severity, occurrence, and detection levels and compare RPN.

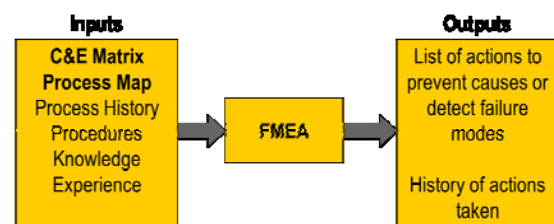

Fig. 6. FMECA inputs and outputs [17]

### 2.3. Risk assessment

The next step of FMECA is risk assessment. It is based on a compilation of forms, resulting in the knowledge of the risk of failure. This risk assessment is a measure of the consequences of failures.

The risk assessment of the system is assigned at the design and planning of the available measures to reduce their occurrence and detection. The measure of this evaluation is an indicator – RPN – level of risk/priority, which consists of three factors:

S - importance of the Severity of the occurrence of failure causes.

O - probability of Occurrence of failure causes.

D - probability of Detection of failure causes, or it's result.

These elements S, O a D can take any value from 1 to 10, where the level of risk is expressed by their mathematical product. [3, 16, 17].

$$\text{Severity} \times \text{Occurrence} \times \text{Detection} = \text{RPN}$$

Fig. 7. RPN

### 3. ANALYSIS OF WEAR AND DAMAGE

Speed and safety of the transport of goods by semi - trailers depend on their technical condition. Further on the analysis of wear and damage to the air brake system is presented, which was performed at the STSZ a.s from Trnava (freight transport company) [4].

Analysis of wear and damage on the air brake system was performed on all components of the EBS system. If wear or damage unacceptable for operation occur on a component of air brake system than it is necessary to replace such component with the new one, since all items are designed as compact and therefore they are not repaired and only replaced.

#### 3.1. Analysis of wear and damage of air brake system

An analysis of wear and damage on air brake system components was done on a fleet composed of 1 470 semi-trailers. Out of them, 800 semi-trailers entered with a failure into the inspection and in case of 670 semi-trailers a failure was found within the maintenance inspection. The following graph (fig. 8) shows the exact number of failed components of air brake system which were replaced in the company during one year for the mileage interval of 75 000 km (that is after 75 000 km, 150 000 km and 225 000 km). When wear or damage is detected on a component, the particular air brake system component has to be replaced [4]. From the analysis the increase of failure numbers depending on kilometers run is evident. The highest number of failures was in case of brake valves – Tristop, pipes, sensors and both coupling heads. This increase of failures should be prevented by change of maintenance scheme, which is discussed hereafter.

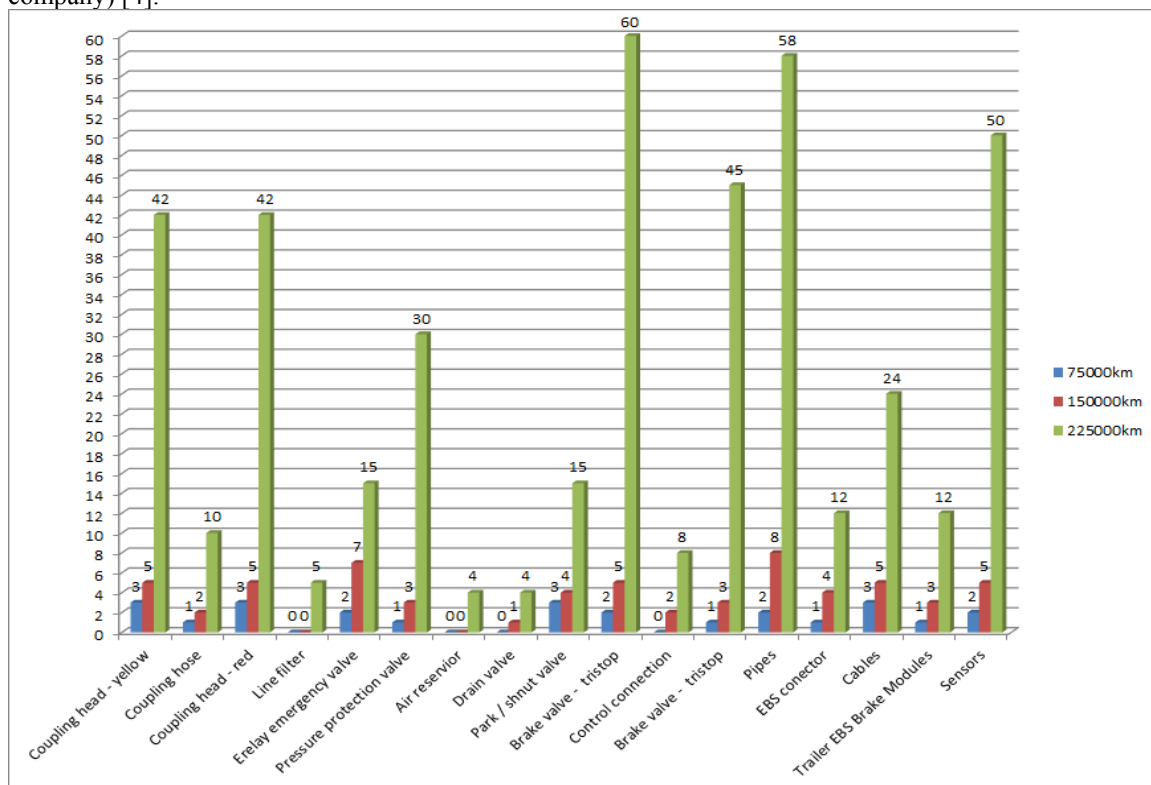

Fig. 8. The number of failures on the air brake system components of 1470 semi-trailers [4]



### 3.2. Air branch of EBS system

We present some examples of real wear and damage of air branches of the EBS system.

#### Brake valve

It provides braking force to the control pressure in the range 0 to 6.5 bar at the wheel brake.

The brake valve is sealed by so called duster; when it burst the brake valve will be damaged.

Any cracks of individual parts are not accepted, so when any crack occurs, the complete brake valve has to be exchanged. A damaged brake valve is shown in fig. 9.

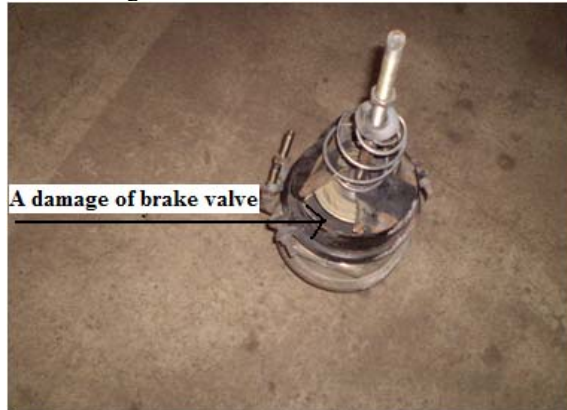

Fig. 9. Damage of brake valve [4]

### 3.3. Electrical branch of EBS system

We present some examples of wear and damage of electrical branches of EBS system.

#### Cables

Power cables must comply with DIN ISO 7638 + CAN, because they feed the entire semi-trailer by electric energy and also provide signal transmission to other components.

In fig. 10 the impact of external mechanical damage (cutting of cables) is shown, resulting in failure of the electrical signal. If the mechanical damage of the package cables occurs then it becomes leaky and the water gets into various parts and it causes oxidation on wiring and thus inaccurate data for EBS modulator may be transferred.

There is no acceptable level of cutting of the cables and therefore the whole damaged part has to be replaced [4].



Fig. 10. Damage of cable [4]

### Trailer EBS brake modules

Trailer EBS brake modules for semi-trailer consist of electronic unit, sensors and pneumatic valves. ABS function and load regulation are integrated into the unit.

The temperature range of the modulator EBS is  $-40^{\circ}\text{C}$  to  $+65^{\circ}\text{C}$ .

The main function is control of the electronic brake system.

If the applied voltage is in the range of 18 to 32 V, the modulator is working properly.

The operation of the semi-trailer can cause a short circuit in an electrical circuit. Then the voltage will be out of operational range and it will stop the semi-trailer during the operation.

If internal fault is determined by diagnosis on EBS modulator, the entire component must be replaced. Damaged EBS modulator is shown in fig. 11 [4].

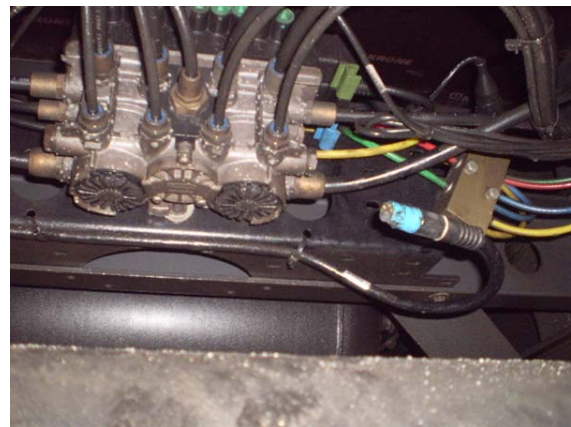

Fig. 11. Damage of trailer EBS brake modules [4]

## 4. MAINTENANCE SCHEME OF SEMI-TRAILERS

### 4.1. Current maintenance scheme of semi-trailers

Every semi-trailer has to be reliable, safe and efficient in service and therefore it should be given an adequate attention. They have to adhere to the principles specified in the maintenance plan for a particular semi-trailer. For the 3-axle sliding tarpaulin platform semi-trailer, the first maintenance inspection, i.e. running in inspection after 5000 km or within two months after delivery of the semi-trailer is prescribed. For the first maintenance inspection the tolerance for kilometers is maximum  $+ / - 2000$  km. The second maintenance inspection and every other will always be after running 75 000 km or will be no later than six months from the date of sale or will be no later than six months since the previous inspection. On the air brake system, the prescribed activities for the particular inspection level have to be done. These activities are: visual inspection and tightness test of individual components using a manometer and check of

individual components of electrical branch with diagnostics [5].

#### 4.2. RPN values for the current maintenance scheme

For the risk assessment of the failure consequences of air brake system level of risk RPN (Risk Priority Number) are very important factors. The level of risk RPN values are normally between 500 to 80, see fig. 12 for air brake system using current methods for the detection of failures. These

values are unacceptable for the road traffic. It is necessary to reduce the value of all the risks to an acceptable value and to reduce value of the consequences of failures to prevent possible losses of human lives (the worst case) and a semi-trailer should permanently be in operational state.

The numbers of 1, 2, 3 etc. represent individual components of air brake system and each numbers have a well-defined cause of failure. For example number 1 is coupling head (yellow) and it is cause of failure is damaged rubber seal.

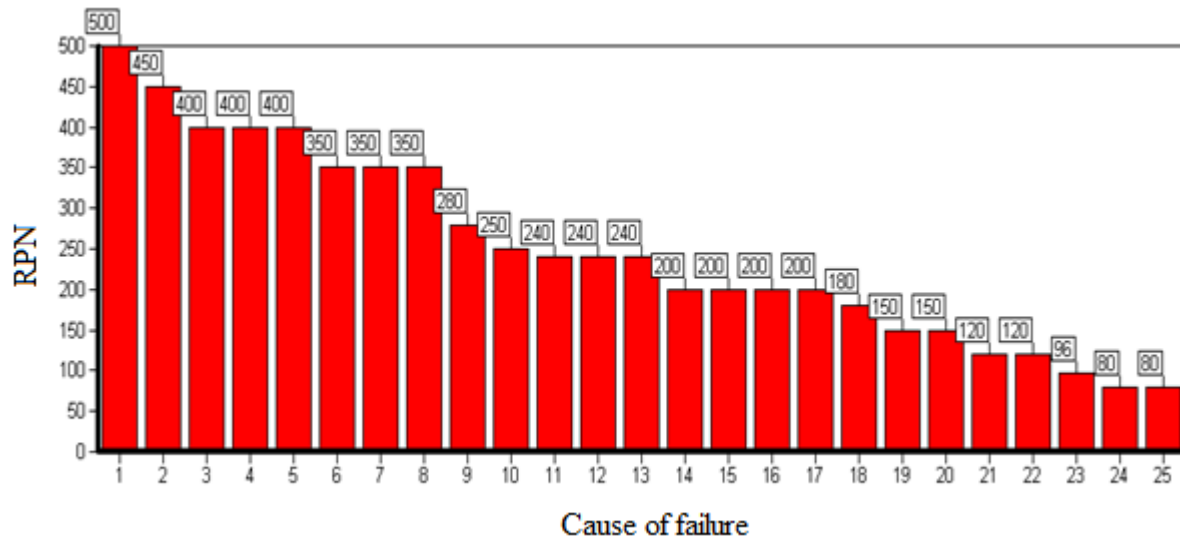

Fig. 12. RPN values of current maintenance scheme

### 5. PROPOSAL OF A NEW MAINTENANCE SCHEME FOR AIR BRAKE SYSTEM

RPN values of the current scheme of maintenance are very high and also the consequences of failures occurring at the individual components of air brake system are of high values, so the current maintenance scheme should be changed. Proposed change will consist of a new interval of planned preventive inspections, using the new methods for the detection of failures of individual components, as well as the use of preventive measures, that is exchanging air brake system components after a certain number of kilometers run by a semi-trailer.

#### 5.1. Proposal of maintenance intervals for air brake system

With the growing number of kilometers traveled there are more worn components and subsequently their failures. The failures may have the highest values the consequences that are loss of human lives or semi-trailer will not be in operational state. The proposed intervals for the service inspections consist of three levels of maintenance interventions, which meet the definition of the preventive maintenance

and are intended to reduce the probability of failure or the degradation of the functioning of an item.

The first level of the preventative maintenance is proposed for every 45 000 km with a tolerance of  $\pm 2 000$  km or will be no later than 4 months from the date of sale or will be no later than 4 months since the previous inspection. Visual inspection is performed only, which is used to detect failures of individual components that could occur in the manufacturing process and will show up within operation after a certain number of kilometers traveled.

The second level of the preventative maintenance is proposed for every 75 000 km with a tolerance of  $\pm 5 000$  km or will be no later than 8 months from the date of sale or will be no later than 8 months since the second inspection. More complex check will be performed with using the proposed methods to detect failures.

This interval is designed by calculating the total cost of the consequences of failures that may arise from the examined 1 470 semi-trailers and costs associated with service inspections that are performed on the 1 470 semi-trailers.

The costs associated with the consequences of failures on the air brake system are approx. 40 000 euros (all prices with VAT). These costs include the average cost of the Slovak Statistical Office and individual insurance in case of loss of human life

and the average price of a new semi - trailer combination and the average price of the cargo carried and the average cost of towing semi-trailer combination from the location of breakdown on a road to the repair shop. The total cost of the 1 470 semi – trailers related to failures consequences of air brake system after running from 0 km to 75 000 km are 999 600 Euro, after running from 75 000 km to 150 000 km are 2 469 600 and after running from 150 000 km to 225 000 km are 17 434 200 Euro.

The average price of a service inspection for one semi - trailer is 193.52 Euro. If the service

inspections will be performed on 1 470 semi - trailers every 15 000 km, the costs associated with service inspections are after running 15 000 km 1 422 372 Euro, after running 30 000 km are 711 186 Euro, after running 45 000 km are 474 124 Euro and after running 60 000 km are 355 593 Euro. Dependences of inspection costs and failure consequences on mileage run are shown in the graph (Fig. 13). Intersection of the two curves is at about 90 000 km and this value is designed for the second level of the preventive maintenance determined at every 90 000 km.

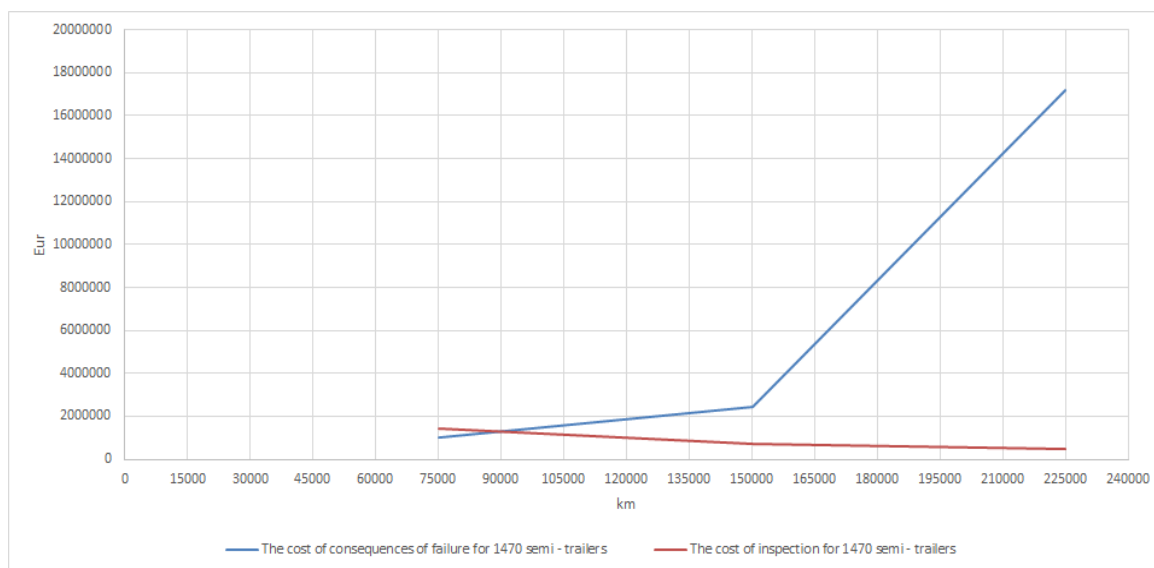

Fig. 13. The costs associated with the consequences of failures and inspections for 1 470 semi-trailers

The third level of the preventive maintenance is proposed for every 180 000 km with a tolerance of +/-5 000 km or will be no later than 16 months from the date of sale or will be no later than 16 months since the third inspection. Exchange of all components of air brake system except air pipes and cables in a professional workplace will be performed.

## 5.2. Proposal of detection measures

In the proposed preventive maintenance, two methods to detect failures - visual inspection and checking of tightness and functionality of using diagnostics are proposed. The role of the visual inspection is based on more frequent intervals by visual inspection to avoid unexpected failures that could have consequences in the loss of human life or in removal of the air brake system from operation.

## 5.3. Proposal of preventive measures

In FMECA analysis, it was found that it is appropriate to change all air brake system

components except pipe and cables after running 180 000 km, thus the current maintenance scheme will be more expensive but minimizes the risk of failures and the consequences associated with them.

## 5.4. RPN values of proposed maintenance system

In fig. 14 we can see that there was a significant reduction in RPN values on proposed detection methods, as well as preventive measures. RPN values for the first stage of the preventive maintenance are in the range from 400 to 60. RPN values range from 80 to 32 when we use preventive measures. The green columns in the picture represent RPN values for individual components and well-defined cause failures when we use the first level of the preventive maintenance.

The numbers of 1 - 25 represent individual components of air brake system; same as in the figure 14.

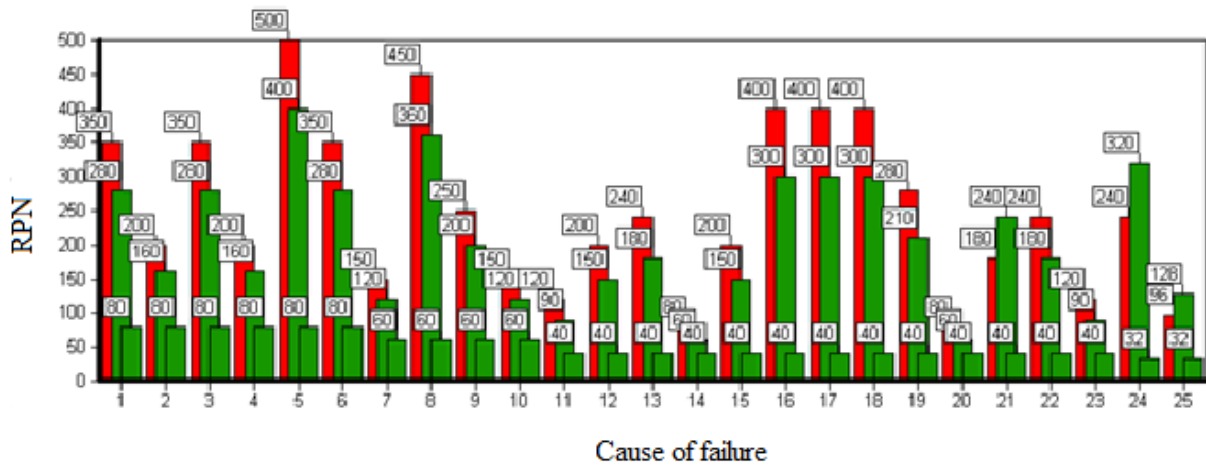

Fig. 14. RPN values for existing and proposed maintenance scheme

## 6. ECONOMIC EVALUATION

The current maintenance scheme has running-in check after running the first 5 000 km, with the average price of 66.8 Euro. Then after running every 75 000 km inspections are carried out for the average price of 232.2 Euro.

The total costs of the current scheme of maintenance for one semi - trailer after running 225 000 km are 799.9 Euro. The proposed maintenance scheme after running every 45 000 km has visual inspection, price of which is 27.1 Euro. After running every 90 000 km all components are checked by using diagnostics. The price is 72 Euro. Then after running 180 000 km there is an exchange of all components of air brake system except pipes and cables. The total exchange price is 1640.7 Euro. The total costs of the proposed maintenance scheme for one semi-trailer after running 225 000 km are 1793.9 Euro.

In the total costs, prices of parts that are exchanged on the basis of proposed preventive measures in the FMECA analysis are included. The total cost of the proposed maintenance scheme includes the instruments that are used to detect failures on individual components, workers' salaries and prices of all components being replaced.

## 7. DISCUSSION ON PROPOSED MAINTENANCE SCHEME

The costs of the proposed maintenance scheme are 2.2 times higher than the costs of the current maintenance scheme after running 225 000 km. The analysis showed that the current maintenance scheme has 32.9% probability that after running 225 000 km there will be a failure in one component of air brake system.

Consequence of failure was estimated in an average of 40 000 Euro. The increased costs of the proposed maintenance scheme are justified because there will be minimization of failures and their

consequences and thus there is a potential to save a human health and lives.

## REFERENCES

- [1] Frank H, J. 2001. *Analyza možných spôsobů a důsledků závad (FMEA)*. 3. Vyd. Praha: Česká společnost pro jakost. 2001. 72 pp. ISBN 80-02-01476-6.
- [2] Galar, D., Gustafson, A., Tormos, B., Berges, L.: *Maintenance Decision Making based on different types of data fusion*. *Eksploatacja i Niezawodność – Maintenance and Reliability* 2012; 14 (2): 135–144., ISSN 1507-2711.
- [3] Grenčík, J. a kol.: *Manažérstvo údržby Synergia teórie a praxe*, vydala Slovenská spoločnosť údržby, BEKI design, s.r.o. Košice, ISBN 978-80-89522-03-3, Košice 2013 p. 373-390.
- [4] Internal documents of STSZ a.s. Trnava.
- [5] Internal documents of PANAV.
- [6] Kamiński, Z.: *Mathematical modelling of the trailer brake control valve for simulation of the air brake system of farm tractors equipped with hydraulically actuated brakes*. *Eksploatacja i Niezawodność – Maintenance and Reliability* 2014; 16 (4): 637–643. ISSN 1507-2711.
- [7] Kamiński, Z., Czaban, J.: *Diagnosing of the agricultural tractor braking system within approval tests*. *Eksploatacja i Niezawodność – Maintenance and Reliability* 2012; 14 (4): 319–326. ISSN 1507-2711.
- [8] Labib, A.W.: *An effective and efficient model for the selection of maintenance strategy*, *Euromaintenance* 2012, May 14-16, Belgrade, DOTS, ISBN 978-86-89141-00-9.
- [9] Loska, A.: *Remarks about modelling of maintenance processes with the use of scenario techniques*. *Eksploatacja i Niezawodność – Maintenance and Reliability* 2012; 14 (2): 92–98., ISSN 1507-2711.
- [10] Matějka, R. 1990. *Vozidla silniční dopravy I*. 2.vyd. Bratislava: Alfa, 1990. 213 s. ISBN 80-05-00392-7.



- [11] Moubray, J.: *Reliability-centered Maintenance*. Industrial Press Inc. New York 1997, ISBN 0-8311-3078-4.
- [12] Pačaiová, H. - Nagyová, A. - Schöpf, G., *Application of risk assessment methods and their management in mining processes in: 1st . Scientific symposium: proceedings, TU Košice 2011*, ISBN 978-80-553-0635-3.
- [13] Ruman, F. 2012. *Návrh údržby vybranej časti návesu jazdnej súpravy: diplomová práca*. Žilina: Žilinská univerzita, 2012. 67 s.
- [14] Schöpf, G., Pačaiová, H., Sinay, J.: *Process FMEA – Principles and Improvements*, In 5th International Mechanical Engineering Forum, 2012, ISBN 978-80-213-2291-2.
- [15] Sobral, J., Ferreira, L.: *Establishment of optimal physical assets inspection frequency based on risk principles*. *Eksploatacja i Niezawodność – Maintenance and Reliability 2015*; 17 (2): 243–249, ISSN 1507-2711, <http://dx.doi.org/10.17531/ein.2015.2.11>.
- [16] Stuchlý, V. – Poprocký R.: *Koncepcia údržby RCM / - 3. vyd. - Žilina : Žilinská univerzita, 2007. - ISBN 978-80-8070-751-4 - 2. vyd. - Žilina : Žilinská univerzita, 2005. - 56 s. : obr., tab. - ISBN 80-8070-367-1*.
- [17] Stuchlý, V. – Poprocký R.: *Údržba strojov a zariadení*. EDIS- vydavateľstvo Žilinskej university, ISBN: 978-80-554-0845-3, Žilina, 2014 p. 152-243.
- [18] Timischl, W., *Qualitätssicherung, Statistische Methoden*, 3. Auflage, pp. 6.
- [19] Vetter, R., <http://home.t-online.de/home/ralf.vetter/kosten.htm>, 2010.
- [20] VLK, F. 2003. *Stavba motorových vozidel*. Brno: VLK, 2003. 499 s. ISBN 80-238-8757-2.



**František RUMAN**, Ing.  
Faculty of Mechanical Engineering, Department of Transport and Handling Machines,  
University of Žilina  
Univerzitná 1,  
010 26 Žilina, Slovakia  
frantisek.ruman@fstroj.uni  
za.sk.



**Juraj GREŇČÍK**, Assoc. prof.  
Faculty of Mechanical Engineering, Department of Transport and Handling Machines,  
University of Žilina  
Univerzitná 1,  
010 26 Žilina, Slovakia  
juraj.grencik@fstroj.uniza.sk.