



ENHANCING THE PERFORMANCE OF SOLAR BOOST CONVERTER USING GREY WOLF OPTIMIZER

Bashar M. SALIH* , Ali N. HAMOODI , Rasha A. MOHAMMED , Ali S. SALIH 

Northern Technical University Technical Engineering College, Department of Electrical Engineering Techniques, Mosul, Iraq

*Corresponding author, e-mail: basharms_tecm@ntu.edu.iq

Abstract

One of the DC-DC conversion systems is boost converters which are used in commonly with solar systems to convert low DC voltage levels to higher ones. This is particularly useful in solar systems because the voltage generated by solar panels can vary widely depending on factors such as the amount of sunlight and the temperature of the panels. The duty cycle of the boost must be controlled to have the maximum output power. Using the Grey Wolf Optimizer to control the duty cycle of a boost converter is one of the ways to have this maximum power. The optimization problem can be stated as minimizing the voltage error of the boost converter output by optimizing the duty cycle. The objective function can be defined as the difference between the desired output voltage and the actual output voltage of the boost converter. The duty cycle can be optimized by adjusting the PWM signal's pulse width that controls the boost converter switch.

Keywords: Boost converter, solar system, grey wolf optimizer, boost converter-based GWO algorithm, optimization techniques

1. INTRODUCTION

MPPT controllers are used extensively in photovoltaic (PV) systems in order to increase power output from solar panels. These controllers change the operating point of the PV system to the MPP without the interference of environmental factors by tracking the changes constantly.

The organization of the Grey Wolf Optimizer is one of the suitable optimization algorithms utilized in MPPT control. GWO is an inspired algorithm based on the mode of grey wolves hunting techniques. Because of its simplicity and efficiency, the method has been successfully applied to solve a vast number of optimization problems [1].

This paper develops a GWO-based MPPT controller that employs the GWO algorithm in search of the PV system's optimal operating point. MPPT and its associated controllers The main form of tracking and its related controller is the maximum power point tracking and GWO-based controller. To maintain the system functioning at its optimum power point, the controller calculates the output power and adjusts the DC-DC converter pulse width. By applying a simple updating equation on each wolf position within the search space, the GWO algorithm finally approach the global optimum for efficient operation of PV system [2].

The GWO-based MPPT controller stands out from other MPPT techniques in the following ways.

Firstly, it offers more compact zero steady-state structural response and better tracking of the optimal solution to maximize the energy that can be fed into the photovoltaic panels. Second, it is partially shade and other environmental conditions which make it very resistant to fluctuating conditions. Last but not least, the GWO algorithm mainly involves minimal computation; a factor suitable for practical implementation in actual operating PV systems.

Overall, with assistance from the GWO optimization algorithm in the proposed MPPT controller, promising results for the power output of solar panel in PV systems can be observed. It considers the GWO algorithm in its tracking of the maximum power point which means higher energy output and improved system performance [3].

2. BOOST CONVERTER

According to figure one, there is a boost converter which is a kind of DC-DC converter that increases voltage of a DC power supply. It achieves this through charging of energy from the input voltage in an inductor then discharging it to the output voltage [4].

The output voltage is higher than the input supply voltage this is brought about by stored energy in the inductor during the on time of switch and releases it during the off time duration of the switching, this boost is always used in the application which have

input voltage is less than the power of the desired load, like in the solar arrays and battery power package [5].

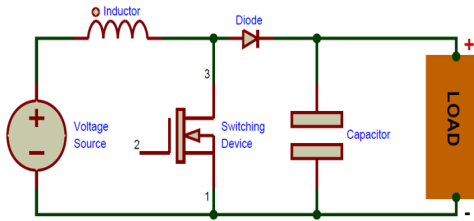

Fig. 1. The boost converter circuit diagram

3. GREY WOLF OPTIMIZER

The social behavior of grey wolves in nature was used in the development of the GWO, a population-based optimization algorithm. The algorithm was developed by Seyedali Mirjalili and Andrew Lewis initially in year 2014. The GWO algorithm is reliant on the hunting behaviour of grey wolves, which involves three main roles: Alpha, beta and delta wolves. In the GWO algorithm each wolf in the population corresponds to a potential solution to an optimization problem. The positions of each wolf in the given search space represent a particular solution as its fitness is set using a particular objective function [6].

The algorithm recalculates the position of the alpha, beta and delta wolves depending on how they hunt at each step. The position of each alpha wolf is then revised using the current best solution; the position of the beta and delta wolves is then revised based on the other wolves in the population [7].

According to the alpha, beta and delta wolves' placements together with an added random exploration factor, the positions of the rest of the population of the wolves are adjusted. This allows the algorithm to carefully scout the search space while also using high potential search space areas [8]. The GWO approach has been cited to be efficient for all sorts of optimization problems ranging from unconstrained to restricted optimization problems. The construction of the algorithm is very easy and takes only a few parameters to change the result. In general, the GWO algorithm can be applied for various optimization problems and proved its efficiency for a series of applications [9, 10].

3.1. GREY WOLF OPTIMIZER ALGORITHM

GWO, the second metaheuristic optimization algorithm shown in Figure 2, is based on the social behaviour of grey wolves.

Mirjalili and other researchers have found out the GWO grey wolf algorithm learning was derived from the method that the grey wolf pack (*Canis lupus*) used in hunting grounds [12-13].

The algorithm is based on the formulation of leader and hunting abilities within the optimization framework. A wolf hunting pack of this type often

contains 5-12 member wolves. Each member has its own function depending on its abilities and status.

The alpha wolf (α) represents the leader of the pack. He leads the group, and is not necessarily the strongest wolf in the pack [14]. The alpha wolf (α) is one of his most important responsibilities, directing the entire herd in the process of lookout for prey. The beta wolf (β) comes in second in status after the leader in the hierarchy and is responsible for arranging the hierarchical wolves in the pack and supporting the leader wolf α in the form of reactions and signals. While the wolf omega (ω) is ranked lowest in the pyramid. The delta wolf (δ) includes all wolves in the pack other than α , β , or ω . Wolves include hunters, scouts, guards, and those who provide service and care for young and old wolves. The algorithm works on the best solution and arrangement, which is $\alpha > \beta > \delta$. The remaining solutions are the solution ω that lies at the bottom of the herd hierarchy [15]. A sports model can be created that represents the process of hunting, pursuing, and surrounding prey with the following sports rates:

$$\vec{D} = |\vec{C} \cdot \vec{Xp}(i) - \vec{X}(i)| \quad (1)$$

$$\vec{X}(i+1) = |\vec{Xp}(i) - \vec{A} \cdot \vec{D}| \quad (2)$$

Where \vec{X} and \vec{Xp} are vectors representing the position of the grey wolf and the prey, while i represent the current iteration number. Thus, the numerical calculation of the coefficient vectors \vec{A} and \vec{C} is as follows:

$$\vec{A} = 2 \cdot \vec{a} \cdot \vec{r}_1 - \vec{a} \quad (3)$$

$$\vec{C} = 2 \cdot \vec{r}_2 \quad (4)$$

The vectors r_1 and r_2 illustrate the random parameters have a value in the range of (0-1) and the vector \vec{a} reduces linearly from (2-0) over iteration course, the position of the hard members around the prey is updating in random way. The α leads the peak in the hunt and the other follow [16]. The mathematical formulation of this process assumes that information about the location of the prey is already available to the α wolf, and accordingly, the β and δ wolves update their location accordingly. The three best solutions for α , β , and δ are highlighted there, while the remaining lookout members in the pack update their positions accordingly as given:

$$\vec{D}_\alpha = |\vec{C}_1 \vec{X}_\alpha - \vec{X}| \quad (5)$$

$$\vec{D}_\beta = |\vec{C}_2 \vec{X}_\beta - \vec{X}| \quad (6)$$

$$\vec{D}_\gamma = |\vec{C}_3 \vec{X}_\gamma - \vec{X}| \quad (7)$$

During hunting, grey wolf members adjust their locations, as given in equations as:

$$\vec{X}_1 = \vec{X}_\alpha - \vec{A}_1 \cdot (\vec{D}_\alpha) \quad (8)$$

$$\vec{X}_2 = \vec{X}_\beta - \vec{A}_2 \cdot (\vec{D}_\beta) \quad (9)$$

$$\vec{X}_3 = \vec{X}_\gamma - \vec{A}_3 \cdot (\vec{D}_\gamma) \quad (10)$$

The candidate solution or best position in the current iteration that works as a tool for updating the grey wolf's whereabouts is provided mathematically as:

$$\vec{X}(i + 1) = \frac{\vec{X}_1 + \vec{X}_2 + \vec{X}_3}{3} \quad (11)$$

The parameter \vec{A} is responsible for exploring and exploiting the algorithm. The GWO flowchart is shown in figure 2.

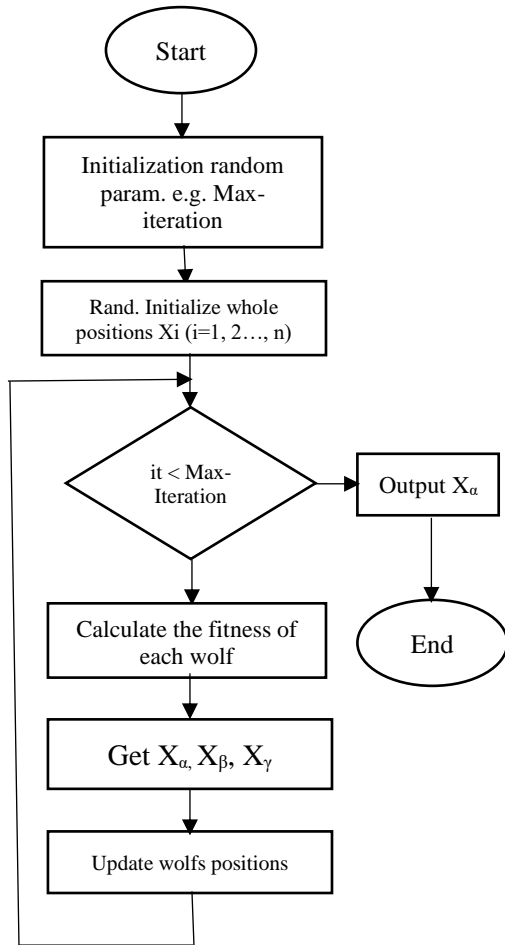

Fig. 2. The grey wolf optimizer flowchart

4. INCREMENTAL ALGORITHM

The slope of the P-V curve is detected by the incremental conduction (IC) technique, and the MPP is tracked by searching for the peak of the P-V curve. Figure 3 is the characteristics of photovoltaic array under different lighting conditions [18].

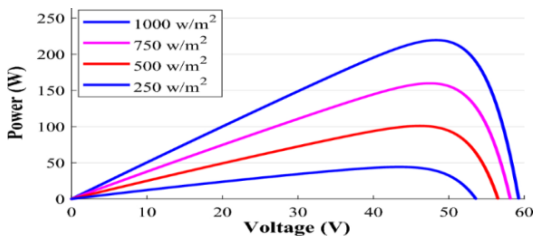

Fig. 3. Characteristics of PV array under different irradiance

For MPPT algorithm, instantaneous I/V coupling and dI/dV incremental coupling are used. The location of PV module MPP on the PV curve is reliant on the relationship between the two values, as shown in (12-13), i.e. (12) indicates that the PV

module work at MPP, while (13) and (14) indicates that the PV panel works on the left and right side of the MPP on the PV curve, respectively.

$$di/dv = -1/V \quad (12)$$

$$di/dv > -1/V \quad (13)$$

$$di/dv < -1/V \quad (14)$$

These equations given from the P-V slope at MPP is zero, i.e.:

$$dp/dv = 0 \quad (15)$$

Rewriting equation 15 lead to:

$$I + V \frac{di}{dv} = 0 \quad (16)$$

In the traditional incremental conduction algorithm, equation (16) is used to adjust the MPP and the current and the voltage of the PV module that are analogies by the MPPT controller. If equation (13) is gratified, then the duty cycle of the DC to DC boost converter should be reduced, and vice versa if equation (14) is satisfied, while there is no change in the duty cycle if equation (16) is satisfied.

5. MPPT ALGORITHM FOR GREY WOLVES OPTIMIZER

The GWO algorithm can be used to optimize the design parameters of the Boost Converter. The duty cycle is used here to change the boost output voltage to improve its efficiency and output power. The GWO algorithm works by simulating the hunting behaviour of grey wolves, which coordinates their hunting behaviour to discover the optimal answer to the optimization problem. About the Boost Converter, the GWO algorithm can be used to find the optimal values of the design duty cycle according to the optimal values of each current and voltage of the PV array that find the maximum power output of the converter. The input voltage and output voltage can be used to find the ideal duty cycle values that used to give the optimal point of each current and voltage of the PV array to optimize the output power of the Boost Converter. The output power of the converter is the objective function to be optimized, which is provided by:

$$V_{out} = V_{in}/(1 - Du) \quad (17)$$

Where V_{in} represents the input voltage, V_{out} denotes the output voltage, and Du denotes the duty cycle.

The hunting behaviour of the wolves is then simulated by updating their positions based on their fitness values, which are computed using the objective function. After a given number of rounds, the alpha wolf's position correlates to the optimal set of duty cycle settings that optimize the boost converter's power output. The Grey Wolf Optimization GWO technique can be used to improve the efficiency and power output of a boost converter. The GWO algorithm simulates grey wolf hunting behaviour to determine the ideal design parameters that maximize the converter's power output [19-20].

6. METHODOLOGY

The focus of this work is on enhancing the operation of a solar power inverter through “grey wolf” algorithm. Next, transformer requirements and design were defined and then the grey wolf variables and related environmental factors. Subsequently, the Grey Wolves algorithm was applied in an attempt to enhance the efficiency of the converter through adjustment of the variables. Lastly, the results were computed and cross-checked to ensure the analysis of the performance of the new Grey Wolves algorithm in the dynamic optimization of the solar energy converter.

7. SIMULATION AND RESULTS

A PV system and a boost converter were simulated using MATLAB/Simulink. MPPT control behaviour and tracking was modified using grey wolf optimizer GWO. Figure 4 shows a solar cell system module with a boost-converter controller. The simulation model consists of solar panels, a boost converter, and a controller that generates the signal of pulses to trigger the boost converter.

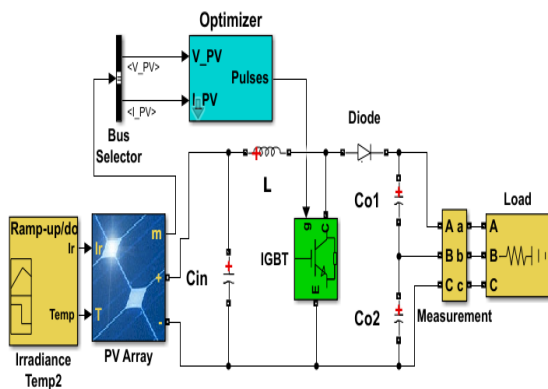

Fig.4. Boost converter-based GWO Simulink circuit

The materials that are used in this research are:

PV Solar Module: the PV that is used in the simulation is SunPower SPR-305E-WHT-D with 66 parallel string and 5 Series-connected modules per string. The parameters are in table 1.

Table 1. PV array parameters

Type	SunPower SPR-305E-WHT-D
Output Power	100kW (Nser=5, Npar=66)
Open Circuit Voltage Voc	64.2V
Short Circuit Current Isc	5.96A
Voltage at maximum power point Vm	54.7V
Current at maximum power point A	5.58A

The boost converter parameters given in table 2.

Table 2. Boost parameters

Type	Boost converter used in figure 4
L	5mH
Cin	100 μ F
Co1&Co2	Each of 12000 μ F
Switching freq.	5kHz

Figure 5 is the input irradiation to the PV array at constant temperature of 25⁰ C.

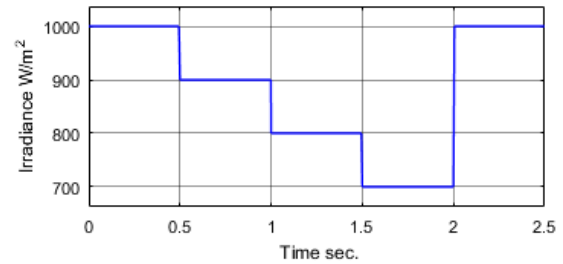
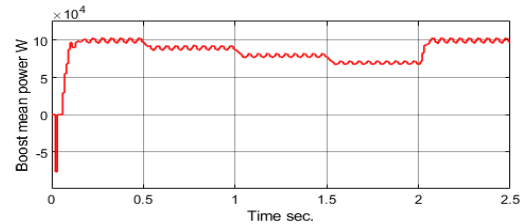
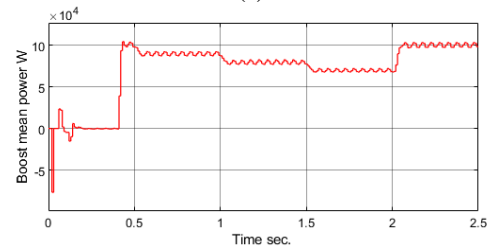

Fig. 5. Input irradiance W/m²

Figure 6 is the output power of the boost converter. (a) is for GWO and (b) is for IC, the GWO output power is more stable and fast response compared with IC one.



(a)



(b)

Fig. 6. The boost convweter output power for GWO and IC res

Figure 7 is the boost converter output voltage. (a) is for GWO and (b) is for IC, the GWO output power is more stable compared with IC one.

Figure 8 is the PV mean power. (a) is for GWO and (b) is for IC, the GWO mean power of PV is more stable and fast response compared with IC one.

Figure 9 is the PV output voltage. (a) is for GWO and (b) is for IC, the GWO voltage of PV is more stable and fast response compared with IC one.

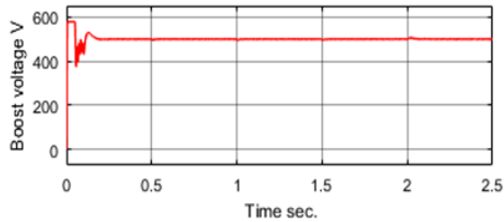

(a)

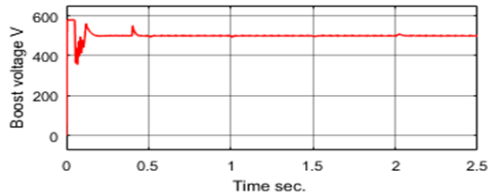

(b)

Fig. 7. The boost convweter output voltage for GWO and IC res

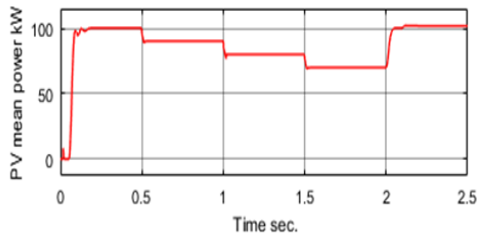

(a)

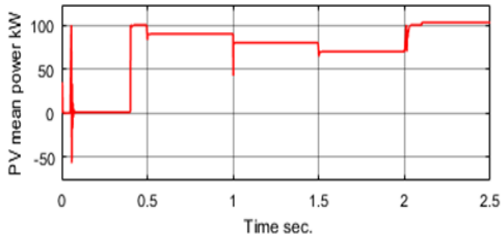

(b)

Fig. 8. The PV mean power for GWO and IC res.

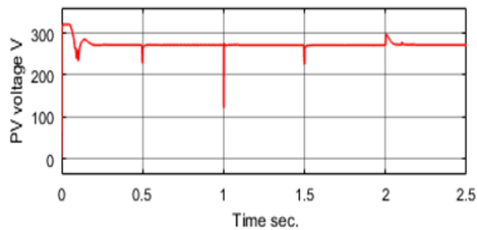

(a)

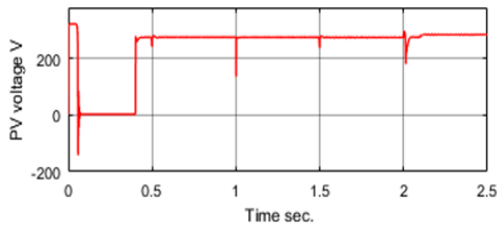

(b)

Fig. 9. The voltage for GWO and IC res.

Figure 10 is the current for boost converter, (a) is for GWO and (b) is for IC.

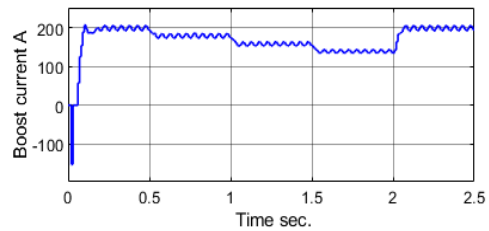

(a)

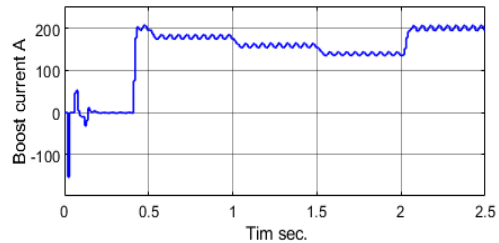

(b)

Fig. 10. The current for GWO and IC res

8. CONCLUSIONS

A module for solar cells with a boost converter was designed using Matlab/Simulink, and the electronic switch MOSFT of the boost converter was controlled and driven by a pulse signal generated by the grey wolf controller.

Grey wolves enhance the performance of the boost converter for the solar cell module by finding the closest values for the solar module voltage as well as the current that produce the greatest power. The process is done by gradually approaching the maximum power value and then capturing, retaining and following up on this value.

The results obtained from the Grey Wolves start-up algorithm were compared to the traditional Incremental method, and the Grey Wolves results were better in terms of the boost output voltages reaches the steady state at 0.2 sec. where in the IC algorithm the voltage reaches the steady state at 0.4 sec., the power of the boost converter also reached the steady state at 0.1 sec. For GWO and at 0.4 sec. For IC algorithm.

GWO is effective in the fields of engineering and numerical optimization thanks to its integration with natural wolf behaviour. This method is also better in terms of cost, as precise controllers are used with low cost and greater development capabilities.

At irradiance 1000W/m², the mean power, which obtained by GWO, as shown in figure 8, remained fix from (0 to 0.5) and the mathematical calculation of power is:

$$P=V.I \tag{18}$$

From array, there are five PV panel connected in series in each string and six strings connected in parallel therefore, V=273.5V and I=368.2A. So, the power P=100.72kW.

The power value appeared similar to the obtained by simulation.

Source of funding: *This research received no external funding.*

Author contributions: *research concept and design, B.M.S., A.N.H., R.A.M., A.S.S.; Collection and/or assembly of data, B.M.S., A.N.H., R.A.M., A.S.S.; Data analysis and interpretation, B.M.S., A.N.H.; Writing the article, R.A.M.; Critical revision of the article, A.S.S.; Final approval of the article, B.M.S., A.N.H., R.A.M., A.A.S.*

Declaration of competing interest: *The authors declare that they have no known competing financial interests or personal relationships that could have appeared to influence the work reported in this paper.*

REFERENCES

- Pradhan A, Panda B. A Simplified design and modeling of boost converter for photovoltaic system. *International Journal of Electrical and Computer Engineering* 2018;8:141–9. <https://doi.org/10.11591/ijece.v8i1.pp141-149>.
- Babaa SA, El Murr G, Faisal M, Srilatha P. Overview of boost converters for photovoltaic systems. *Journal of Power and Energy Engineering* 2018; 6: 16-31.
- Donadi AK, Jahnvi WV. Review of DC-DC converters in photovoltaic systems for MPPT systems. *International Research Journal of Engineering and Algorithm* 2019; 06(06).
- Sinha S, Das S, Bhattacharya A. Grey wolf optimizer-based design and performance analysis of a boost converter. *Journal of Intelligent and Fuzzy Systems* 2018; 34(1): 71-80.
- Kumar A, Singh R. Design optimization of boost converter using grey wolf optimizer. 2017 International Conference on Circuit, Power and Computing Technologies (ICCPCT) 2017; 1-6: 2017.
- Hannan MA, Beg MRA, Alam MS. Design optimization of boost converter using grey wolf optimizer. 2017 IEEE Region 10 Humanitarian Algorithm Conference (R10-HTC) 2017; 1-4: 2017.
- A Ahmed, AHM Zahirul Alam. Design optimization of DC-DC boost converter using grey wolf optimizer. 2018 6th International Conference on Electrical Engineering and Information & Communication Algorithm (ICEEICT) 2018; 1-5: 2018.
- Singh SN, Kumar N. Performance optimization of DC-DC boost converter using grey wolf optimizer. 2018 2nd International Conference on Power, Circuit and Information Technologies (ICPCIT) 2018; 218-223: 2018.
- Ren H, Liu Y, Sun Y, Liu Y. Optimal design and control of a photovoltaic system using a boost converter and improved gravitational search algorithm. *Applied Energy* 2015; 149: 203-211.
- Hassan MM, Mohamed A, Al-Quraishi AM. Optimal design and control of a boost converter for photovoltaic systems using particle swarm optimization. *International Journal of Electrical Power & Energy Systems* 2015; 72: 39-47.
- Nadimi-Shahraki MH, Taghian S, Mirjalili S. An improved grey wolf optimizer for solving engineering problems. *Expert Systems with Applications* 2021; 166: 113917. <https://doi.org/10.1016/j.eswa.2020.113917>.
- Sanei SG, Ebrahimi R, Shayeghi H. Optimal design of a boost converter for solar photovoltaic applications using whale optimization algorithm *Solar Energy* 2019; 178: 40-54.
- Huang Y, Zhu X, Tse MC. A hybrid algorithm for MPPT of photovoltaic systems using a boost converter. *IEEE Transactions on Power Electronics* 2017; 32(1): 694-704.
- Li R, Zhang Y, Hu J, Li Y. An improved genetic algorithm based MPPT for photovoltaic power generation system using boost converter. *International Journal of Electrical Power & Energy Systems* 2013; 53: 107-116.
- Mirjalili S, Mirjalili SM, Lewis A. Grey Wolf Optimizer. *Advances in Engineering Software* 2014; 69: 46–61. <https://doi.org/10.1016/j.advengsoft.2013.12.007>.
- Almufti SM, Hawar B, Ahmad, Ridwan B, Marqas, Renas R, Asaad. Grey wolf optimizer: Overview, modifications and applications. 2021. <https://doi.org/10.5281/ZENODO.5195644>.
- Ghalambaz M, R Jalilzadeh Yengejeh, AH Davami. Building energy optimization using Grey Wolf Optimizer (GWO). *Case Studies in Thermal Engineering* 2021; 27: 101250. <https://doi.org/10.1016/j.csite.2021.101250>.
- Aguila-Leon J, Chiñas-Palacios C, Vargas-Salgado C, Hurtado-Perez E, Garcia EXM. Particle swarm optimization, genetic algorithm and Grey Wolf optimizer algorithms performance comparative for a DC-DC boost converter PID controller. *Advances in Science, Technology and Engineering Systems Journal* 2021; 6(1): 619–25. <https://doi.org/10.25046/aj060167>.
- Kaveh A, Zakian P. Improved GWO algorithm for optimal design of truss structures. *Engineering with Computers* 2018; 34(4): 685–707. <https://doi.org/10.1007/s00366-017-0567-1>.
- Seyyedabbasi A, Kiani F. I-GWO and Ex-GWO: improved algorithms of the Grey Wolf Optimizer to solve global optimization problems. *Engineering with Computers* 2021; 37(1): 509–32. <https://doi.org/10.1007/s00366-019-00837-7>.



Bashar Mohamed SALIH

obtained a bachelor's degree. He obtained a Master's degree (1998) and a Master's degree (2006) in Electrical Power Engineering from the University of Algorithm. He works in electrical engineering and is a specialist and lecturer in the Electrical Power Algorithm Engineering Department. He is part of a specialized research team at the Northern Technical University (NTU) Engineering Technical College, Mosul - Iraq
E-mail: Basharms_tecm@ntu.edu.iq

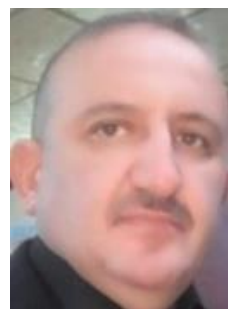

Ali Nathim HAMOODI

Obtained his M.sc (2000), and ph.d (2011) in Electrical Engineering From the University of Aleppo, Syria, currently, he had a titular (Assis.Prof.) in 2018. Specializing in High Voltage at Northern Technical University (NTU) Engineering Technical College, Mosul-Iraq.

E-mail: ali_n_hamoodi@ntu.edu.iq



**Rasha Abd A-Inafaa
MOHAMMED**

B.sc (2006), M.sc (2017) in Electrical Power Engineering from Mosul University, she is Working as Alecturer in the Electrical Engineering Specializing in Electrical Power at Northern Technical University (NTU) Technical College of Engineering, Mosul-Iraq.

E-mail: rashana8479@ntu.edu.iq



Ali Salah ALHFIDH

obtained his M.Sc. from the Northern Technical University in (2021) in Electrical Power Technologies Engineering. Currently he is working as a lecturer in the Electrical Power Engineering specializing, at Northern Technical University-Mosul-Iraq.

E-mail: ali.alhafidh@ntu.edu.iq.